



SM1500 - series
1500 watts DC POWER SUPPLIES

SM 15-100	0 - 15 V	0 - 100 A
SM 35-45	0 - 35 V	0 - 45 A
SM 52-30	0 - 52 V	0 - 30 A
SM 70-22	0 - 70 V	0 - 22 A
SM 120-13	0 - 120 V	0 - 13 A
SM 300-5	0 - 300 V	0 - 5 A

Autoranging

SM 52-AR-60	0 - 26 V	0 - 60 A
	0 - 52 V	0 - 30 A
SM 400-AR-8	0 - 200 V	0 - 8 A
	0 - 400 V	0 - 4 A

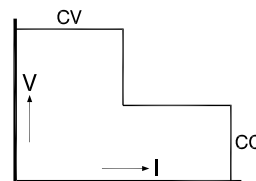
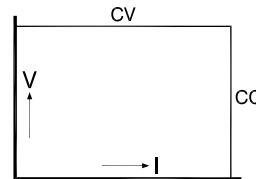

- Efficiency up to 91 %.
- Weight only 9.9 kg
- Wide input voltage range: 90 - 265 VAC, 48-62 Hz
- Active Power Factor Correction, PF=0.99
- 100 kHz MOSFET power conversion technique
- 0 - 5 V analog programmable (on both voltage and current)
- Isolated analog programming with optional ISO AMP CARD to prevent earth loops
- **Ethernet, IEEE488** or **RS232** programming with optional internal interface cards
- Very low HF-emission, OK for **light** industrial environment, immunity OK for **industrial** environment

- Very low output ripple and spikes
- Very stable output voltage or current ($6 \cdot 10^{-5} - 10^{-4}$)
- Excellent dynamic response to load changes
- Master / Slave parallel and series operation with equal current and voltage sharing
- Designed for long life at full power
- Protected against all overload and short circuit conditions
- V and I control with 10-turn potentiometers, resolution 0.03 %. Optional with digital encoders
- Silent blower, only runs when needed, variable speed
- 48 hours burn-in

	SM 15-100	SM 35-45	SM 52-30	SM 52-AR-60	SM 70-22	SM 120-13	SM 300-5	SM 400-AR-8
Output								
voltage	0 - 15 V	0 - 35 V	0 - 52 V	0 - 52 V	0 - 70 V	0 - 120 V	0 - 300 V	0 - 400 V
current	0 - 100 A	0 - 45 A	0 - 30 A	0 - 60 A	0 - 22 A	0 - 13 A	0 - 5 A	0 - 8 A
AUTORANGING (2 ranges) max. output current / voltage	no -	no -	no -	yes 60 A / 0-26 V 30 A / 26-52 V	no -	no -	no -	yes 8 A / 0-200 V 4 A / 200-400V
Input								
AC single phase, 48 - 62 Hz	90 - 265 V	90 - 265 V	90 - 265 V	90 - 265 V	90 - 265 V	90 - 265 V	90 - 265 V	90 - 265 V
<i>Power Derating vs input:</i>								
90 V : P _{out max} (W), I _{in} (A)	1170,16	1185, 16	1200,16	1200,16	1200,16	1200,16	1200,16	1200,16
100 V : P _{out max} (W), I _{in} (A)	1317, 16	1334, 16	1350,16	1350,16	1350,16	1350,16	1350,16	1350,16
110 V : P _{out max} (W), I _{in} (A)	1492, 16	1498, 16	1505,16	1505,16	1505,16	1505,16	1500,16	1505,16
230 V : P_{out max} (W), I_{in} (A)	1500, 7.5	1575, 7.7	1560, 7.7	1560,7.7	1540, 7.6	1560, 7.7	1500, 7.4	1600, 7.8
power factor, 100%, 50% load	0.99, 0.98	0.99, 0.98	0.99, 0.98	0.99, 0.98	0.99, 0.98	0.99, 0.98	0.99, 0.98	0.99, 0.98
internal fuses	25 AT	25 AT	25 AT	25 AT	25 AT	25 AT	25 AT	25 AT
standby input power (Vo=Io=0)	12 W	12 W	12 W	12 W	12 W	12 W	12 W	12 W
standby input power (Vo=V _{max})	22 W	22 W	22 W	22 W	22 W	22 W	22 W	25 W
				26 V / 52 V				200 V / 400 V
Efficiency								
AC 230 V input, full load	87 %	90 %	90 %	89 / 90 %	90 %	90 %	91 %	90 / 91%
AC 115 V input, max. load	83 %	86 %	86 %	84%	86 %	86 %	86 %	86%
Regulation								
Load 0 - 100% CV	0.5 mV	1 mV	2 mV	2 mV	2.5 mV	4 mV	10 mV	12 mV
Line 120 - 265 V AC CV (measured on sense block)	0.2 mV	0.5 mV	0.7 mV	0.7 mV	1 mV	2 mV	3 mV	4 mV
Load 0 - 100% CC	5 mA	3 mA	1.5 mA	2 mA	1 mA	0.6 mA	0.5 mA	0.5 mA
Line 120 - 265 V AC CC (internal voltage sense)	1 mA	0.5 mA	0.5 mA	1 mA	0.25 mA	0.2 mA	0.1 mA	0.2 mA
Ripple + noise								
rms (BW=300 kHz) CV	2 mV	1.8 mV	2 mV	2 mV	3 mV	7 mV	7 mV	15 mV
p-p (BW=50 MHz) CV	8 mV	8 mV	15 mV	15 mV	15 mV	30 mV	50 mV	80 mV
rms (BW=300 kHz) CC	15 mA	5 mA	3 mA	10 / 3 mA	3 mA	2 mA	0.5 mA	1.2 / 0.6 mA
p-p (BW=50 MHz) CC	80 mA	15 mA	10 mA	30 / 10 mA	10 mA	6 mA	4 mA	6 / 3 mA
<i>CC-ripple at full load</i>								
Temp. coeff., per °C	CV				35.10 ⁻⁶			
	CC				60.10 ⁻⁶			
Stability								
after 1 hr warm-up during 8 hrs	CV				6.10 ⁻⁵			
	CC				9.10 ⁻⁵			
t _{amb} = 25 ± 1 °C, V _{in} = 230 VAC (int. voltage sensing for CC-stab.)								

Analog Programming	CV	CC
Programming inputs		
input range	0 - 5 V	0 - 5 V
accuracy	± 0.2%	± 0.5%
offset	- 0.1 ... +1.3 mV (on 5V)	0 ... +2.2 mV (on 5V)
temp. coeff. offset	10 μV / °C	50 μV / °C
input impedance	> 1 MOhm	> 1 MOhm
Monitoring output		
output range	0 - 5 V	0 - 5 V
accuracy	± 0.2%	± 0.5%
offset	- 1... 0 mV (on 5V)	- 1.1... 0 mV (on 5V)
temp. coeff. offset	3 μV / °C	60 μV / °C
output impedance	2 Ohm / max. 4 mA	2 Ohm / max. 4 mA

Reference voltage on prog. connector	V _{ref} TC	5.114 V ± 15 mV (R _o = 2 Ohm, max. 4 mA) 20 ppm
+12V output on prog. Connector	V _o I _{max} R _o	12 V ± 0.2 V 0.2 A 3 Ohm
Relay Outputs ACF DCF	AC - Fail DC - Fail ¹⁾	both NO and NC contact both NO and NC contact ¹⁾ output voltage ± 5% beyond set point

Status outputs CC - status LIM- status OT - status PSOL - status ACF - status DCF - status	CC - operation CV or CC limit Over Temperature Power Sink Overload AC - Fail DC - Fail ²⁾	5V = logic 1 (Ro = 500 Ohm) 5V = logic 1 (Ro = 500 Ohm) 5V = logic 1 (Ro = 500 Ohm) 5V = logic 1 (Ro = 500 Ohm) 5V = logic 1 (Ro = 500 Ohm) 5V = logic 1 (Ro = 500 Ohm)	²⁾ output voltage \pm 5% beyond set point
Remote shutdown	with + 5V, 1 mA or relay contact		
Interlock	contact at rear panel, see photo of rear panel on page 1-6		
Indicators (front panel)	Voltage meter, Ampere meter, AC-Fail, DC-Fail, Over Temperature, Power Sink Overload, Remote-Shutdown, Remote-CV, Remote-CC, Output On, CV-limit, CC-limit, CV- and CC- mode		
Controls (front panel)	Mains on/off switch, CV-and CC-potmeter, CV- and CC-limit-potmeter, Display-Settings button, Display-Limits button, Remote/Local button, Output On/Off button, Frontpanel Lock button.		

Programming speed <i>Standard Version</i>	SM 15-100	SM 35-45	SM 52-30	SM 52-AR-60	SM 70-22	SM 120-13	SM 300-5	SM 400-AR-8
Rise time (10 - 90%) output voltage step time, (100 % load) time, (10 % load)	0 \rightarrow 15 V 6.1 ms 2.1 ms	0 \rightarrow 35 V 15.4 ms 5.1 ms	0 \rightarrow 52 V 7.3 ms 2.4 ms	0 \rightarrow 26 V 8.5 ms 2.8 ms	0 \rightarrow 70 V 13.2 ms 4.4 ms	0 \rightarrow 120 V 3.4 ms 2 ms	0 \rightarrow 300 V 9 ms 3.9 ms	0 \rightarrow 200 V 3.7 ms 2.6 ms
output voltage step time, (100 % load) time, (10 % load)	- - -	- - -	- - -	0 \rightarrow 52 V 34.2 ms 11 ms	- - -	- - -	- - -	0 \rightarrow 400 V 15 ms 5 ms
Fall time (90 - 10%) output voltage step time, (100 % load) time, (10 % load)	15 \rightarrow 0 V 6.1 ms 61 ms	35 \rightarrow 0 V 14.7 ms 147 ms	52 \rightarrow 0 V 7 ms 70 ms	26 \rightarrow 0 V 8.2 ms 82 ms	70 \rightarrow 0 V 12.9 ms 129 ms	120 \rightarrow 0 V 3.3 ms 33 ms	300 \rightarrow 0 V 9 ms 90 ms	200 \rightarrow 0 V 3.5 ms 35 ms
output voltage step time, (100 % load) time, (10 % load)	- - -	- - -	- - -	52 \rightarrow 0 V 33 ms 330 ms	- - -	- - -	- - -	400 \rightarrow 0 V 14.2 ms 142 ms
Programming speed <i>High Speed Version</i>	SM 15-100 <i>option P210</i>	SM 35-45 <i>option P211</i>	SM 52-30 <i>option P212</i>	SM 52-AR-60 <i>option P213</i>	SM 70-22 <i>option P214</i>	SM 120-13 <i>option P215</i>	SM 300-5 <i>option P216</i>	SM 400-AR-8 <i>option P217</i>
Rise time (10 - 90%) output voltage step time, (100 % load) time, (10 % load)	0 \rightarrow 15 V 0.20 ms 0.11 ms	0 \rightarrow 35 V 0.27 ms 0.14 ms	0 \rightarrow 52 V 0.31 ms 0.23 ms	0 \rightarrow 26 V 0.44 ms 0.43 ms	0 \rightarrow 70 V 0.47 ms 0.30 ms	0 \rightarrow 120 V 0.46 ms 0.27 ms	0 \rightarrow 300 V 1.0 ms 0.51 ms	0 \rightarrow 200 V 0.35 ms 0.33 ms
output voltage step time, (100 % load) time, (10 % load)	- - -	- - -	- - -	0 \rightarrow 52 V 0.53 ms 0.34 ms	- - -	- - -	- - -	0 \rightarrow 400 V 0.98 ms 0.59 ms
Fall time (90 - 10%) output voltage step time, (100 % load) time, (10 % load)	15 \rightarrow 0 V 0.21 ms 1.6 ms	35 \rightarrow 0 V 0.33 ms 3.5 ms	52 \rightarrow 0 V 0.38 ms 3.9 ms	26 \rightarrow 0 V 0.27 ms 3.2 ms	70 \rightarrow 0 V 0.78 ms 8.3 ms	120 \rightarrow 0 V 0.51 ms 4.5 ms	300 \rightarrow 0 V 1.40 ms 13 ms	200 \rightarrow 0 V 0.35 ms 3.8 ms
output voltage step time, (100 % load) time, (10 % load)	- - -	- - -	- - -	52 \rightarrow 0 V 1.0 ms 9.7 ms	- - -	- - -	- - -	400 \rightarrow 0 V 1.7 ms 18 ms
Ripple @ full load (rms/pp) @full load (rms/pp)	15 / 50 mV	50/115 mV	55 / 135 mV	26 V / 60 A 30 / 105 mV 52 V / 30 A 25 / 90 mV	45/150 mV	20 / 80 mV	25 / 115 mV	200 V 85 / 355 mV 400 V 60 / 245 mV
Output capacitance	390 μ F	190 μ F	91 μ F	195 μ F	113 μ F	21 μ F	10 μ F	7 μ F

Notes: All specifications regarding programming speed are typical and measured on a resistive load.

	SM 15-100	SM 35-45	SM 52-30	SM 52-AR-60	SM 70-22	SM 120-13	SM 300-5	SM 400-AR-8
Recovery time recovery within di/dt of load step output voltage time, @ 50 - 100% load step max. deviation @ 230 VAC input voltage	50 mV 1.5 A/ μ s 14 V 100 μ s 200 mV	50 mV 0.8 A/ μ s 30 V 100 μ s 150 mV	100 mV 0.5 A/ μ s 48 V 100 μ s 250 mV	26 V / 52 V 60 mV 1.0 / 0.5 A/ μ s 24 / 48 V 100 / 100 μ s 200 / 100 mV	100 mV 0.4 A/ μ s 65 V 100 μ s 200 mV	0.7 V 0.2 A/ μ s 110 V 100 μ s 2.2 V	1.0 V 0.1 A/ μ s 280 V 100 μ s 1.5 V	200 V / 400 V 1.0 / 0.5 V 0.2 / 0.1 A/ μ s 185 / 370 V 100 / 100 μ s 2.5 / 1.5 V
Output impedance CV, 0-1 kHz CV, 1-100 kHz	< 1.3 m Ω < 25 m Ω	< 1.7 m Ω < 30 m Ω	< 3.5 m Ω < 30 m Ω	< 3.3 m Ω < 40 m Ω	< 7.5 m Ω < 30 m Ω	< 63 m Ω < 0.6 Ω	< 125 m Ω < 1 Ω	< 83 m Ω < 1.3 Ω
Pulsating load max. tolerable AC component of load current f > 1 kHz f < 1kHz	15 A rms 100 A peak	15 A rms 45 A peak	13 A rms 30 A peak	20 A rms 30 / 60 Apk	13 A rms 22 A peak	2.5 A rms 13 A peak	1.2 A rms 5 A peak	0.8 Arms 8 / 4 Apeak

Insulation input / output creepage / clearance	3750 Vrms (1 min.) 8 mm
input / case output / case	2500 Vrms 600 V DC
Safety	EN 60950 / EN 61010
EMC Power Supply Standard	EN 61204-3 , Emission: residential, light industrial environment (CISPR22-Class B) Immunity: industrial environment
Generic Emission Generic Immunity	EN61000-6-3 , residential, light industrial environment (EN55022 B) EN61000-6-2 , industrial environment
Operating Temperature at full load	- 20 to + 50 °C derate output to 75% at 60 °C
Humidity	max. 95% RH, non condensing, up to 40 °C max. 75% RH, non condensing, up to 50 °C
Storage temperature	- 40 to + 85 °C
Thermal protection	Output shuts down in case of insufficient cooling
MTBF	500 000 hrs

Hold-Up time Vout = 100%, Iout = 100% Vout = 85%, Iout = 100% Vout = 100%, Iout = 50% @ 230 VAC input	16 ms 20 ms 36 ms (time till DC-fail = 1)
Turn on delay after mains switch on	480 ms @ 230 Vac, 700ms @ 115Vac
Inrush current	27A@115Vac, 22A@230Vac

Series operation max. total voltage Master / Slave operation	600 V yes
Parallel operation max. total current Master / Slave operation	no limit max. 4 units (including Master)
Remote sensing max. volt. drop per load lead	2 V
Limits Voltage adjust range Current adjust range	0 - 102% 0 - 102%
Potentiometers front panel control with knobs resolution screwdriver adjustment	standard 0.03 % option P001 (at front panel)
	SM 15-100 SM 35-45 SM 52-30 SM 52-AR-60 SM 70-22 SM 120-13 SM 300-5 SM 400-AR-8
Meters scale voltage scale current accuracy read output read limit setting (d = digit)	3.5 digit 0 - 15.00 V 0 - 100.0 A 0.5% + 2 d 2% + 2 d
	3.5 digit 0 - 35.0V 0 - 45.0 A 0.5% + 2 d 2% + 2 d
	3.5 digit 0 - 52.0V 0 - 30.0 A 0.5% + 2 d 2% + 2 d
	3.5 digit 0 - 52.0V 0 - 60.0 A 0.5% + 2 d 2% + 2 d
	3.5 digit 0 - 70.0V 0 - 22.0 A 0.5% + 2 d 2% + 2 d
	3.5 digit 0 - 120.0 V 0 - 13.00 A 0.5% + 2 d 2% + 2 d
	3.5 digit 0 - 300 V 0 - 5.00 A 0.5% + 2 d 2% + 2 d
	3.5 digit 0 - 400 V 0 - 8.00 A 0.5% + 2 d 2% + 2 d

Mounting	Stacking of units allowed, air flow is from left to right.
Input Connector	IEC320/C20, EN60320/C20
Output Terminals	M8 bolts
Programming connector	15 pole D-connector at rear panel (FEMALE)
Cooling audio noise level airflow	Low noise blower, fan speed adapts to temperature of internal heatsink. ca.45 dBA at full load, 25 °C ambient temperature, 1 m distance ca. 50 dBA at full load, 50 °C ambient temperature, 1 m distance from left to right
Enclosure degree of protection	IP20
Dimensions behind front panel: h x w x d front panel: h x w	89 x 442 x 365 mm (feet removed) 89 x 483 mm (19", 2 U)
Weight	9.9 kg

Digital Encoders

- CV and CC encoders with a very long life time and intelligent functions (e.g. Keylock).

OPTION P220**Screwdriver adjustment standard potentiometers**

- CV and CC knobs are moved backwards to avoid accidental adjusting.

OPTION P001**Master / slave operation**

- Parallel and Series operation with equal Current and Voltage sharing.
- This way two or more SM-units can be used together as one high power unit.
- Voltage and current of the units is controlled by the master (by potentiometers or by programming).
- Easy to connect in Master / Slave-mode, using standard UTP-cables (RJ45).
Standard on all SM1500 units, no special option required.

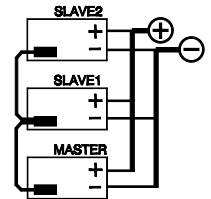
**Battery Charging**

- The CV / CC regulated power supplies are ideal battery chargers. Once set at the correct output voltage, the battery will charge constantly without overcharging. This can be useful for **emergency power systems**.
- Use a circuit-breaker in series to protect the internal diode from reverse connection of the battery.
- Some units need an **external diode set** on the output as extra protection for the internal diode.
- Ordering information for diode set:*



	SM52-30	SM52-AR-60	SM120-13	SM300-5	SM400-AR-8
option	P197	P198	P199	P200	P201

Download the special datasheet for more details from 'www.DeltaPowerSupplies.com'.

Increased max. output voltage/current**OPTION P069**

- The maximum output voltage or current can be increased by approximately 10%. Normally this results in a derating of the maximum ambient temperature or other parameters.
- Always add increased value for voltage or current in ordercode, for example **SM35-45 P069 output 38V**.
For exact details consult the technical department, email 'Support@Delta-Elektronika.nl'.

Enforced secondary isolation 1000 V**OPTION P089**

- The secondary isolation between output and ground is increased from standard 600 V to 1000 V .

High Speed Programming

- The speed is **10 - 20 times higher** because of the smaller output capacitors.
- Relatively low current overshoots (if any) in case of sudden voltage variations caused by the load, this is of great advantage for laser diode applications.
- Applications:*
- Laser diode** power supply, continuous or pulsed.
- Test systems requiring a fast settling time to improve throughput of factory.
- A constant current source with a low parallel capacitance: plasma, load sensitive to current overshoots, etc.
- A constant current source on a load with **fast voltage variations**.
- Ordering information:*

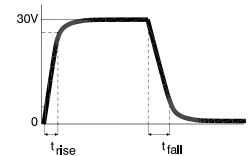

	SM15-100	SM35-45	SM52-30	SM52-AR-60	SM70-22	SM120-13	SM300-5	SM400-AR-8
option	P210	P211	P212	P213	P214	P215	P216	P217

Download the special datasheet for more details from 'www.DeltaPowerSupplies.com'.

Power Sink for 2 quadrant operation

- Can absorb **200W peak power**.
- Maintains output voltage regardless output power is positive or negative (source & sink).
- Ideal solution for supplying **electric motors** with PWM-speed control.
- Fast down programming at no load conditions.
- Ordering information:*

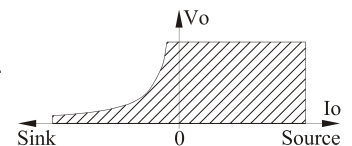

	SM15-100	SM35-45	SM52-30	SM52-AR-60	SM70-22
option	P202	P203	P204	P205	P206

Download the special datasheet for more details from 'www.DeltaPowerSupplies.com'.

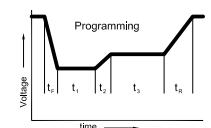
Built-in Ethernet Power Supply Controller**OPTION P177****Built-in RS232 Power Supply Controller****OPTION P183****Built-in IEEE488 Power Supply Controller****OPTION P184****Built-in ISO AMP CARD for isolated analog programming****OPTION P218**

Note: there is only room for one of the interfaces in a unit (P177, P183, P184, P218)

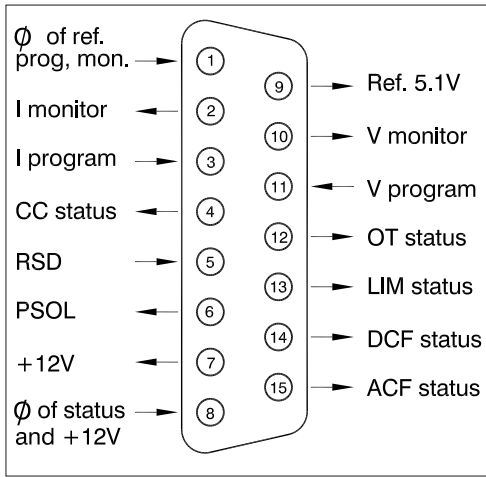

connections programming connector

CV = Constant Voltage
 CC = Constant Current

Specifications measured at $t_{amb} = 25 \pm 5^\circ C$ and $V_{in} = 230V AC$, 50 Hz, unless otherwise noted.

The information in this document is subject to change without notice

